

# Oyster Lamps





# Oyster Lamps

Made in casted recycled aluminium, the Oyster Wall Lamp has a decorative, organic shape due to its soft, lively curves. Reminiscent of oyster shells gathered at the beach, the texture and finish of the lamp has a distinctive, rough expression owing to the casting process, and the interplay between its curved shape and raw surface creates a compelling contrast. Designed with an LED light source, the Oyster Wall Lamp plays with light and shadow to highlight the uniqueness of the material as well as its organic shape.

## PRODUCT INFO

- Product type:** Lighting for indoor use only.  
For contract sales and contract use please contact us for further information.  
Exclusively approved for sale in the EU, Norway, Switzerland and UK
- Country of origin:** China
- Care instructions:** Wipe with a damp cloth
- Please note:** Bulb and black cable are included with Oyster Table Lamp and Oyster Wall Lamp. Oyster Lamps comes with 2.6 metre black cord. Light bulb included.

## OYSTER TABLE LAMP RATING & BULB SPECIFICATION

- Voltage:** 220-240V
- Frequency:** 50Hz
- Certifications:** IP20, CE, UKCA.  
Only approved for EU/NO/CH/UK.  
UK plug version for UK. Separate version for US
- Classification:** Class II
- Recommended light source:** Dimmable LED Opal light bulb E14, 4 watt bulb included
- Cord specifications:** 2.6 metre black cable

## OYSTER WALL LAMP RATING & BULB SPECIFICATION

- Voltage:** 220-240V
- Frequency:** 50Hz
- Certifications:** IP20, CE, UKCA.  
Only approved for EU/NO/CH/UK.  
UK plug version for UK. Separate version for US
- Classification:** Class II
- Recommended light source:** Dimmable LED strip, 8W, 730LM, 2500K, CRI >90
- Cord specifications:** 2.6 metre black cable with dimmer switch



OYSTER TABLE LAMP

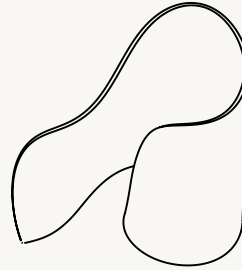

Diameter: 17,3 cm / 6.8 in

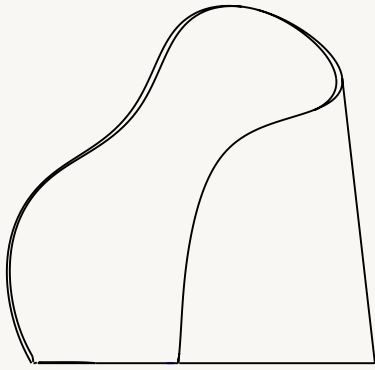

Height: 23,6 cm / 9.3 in

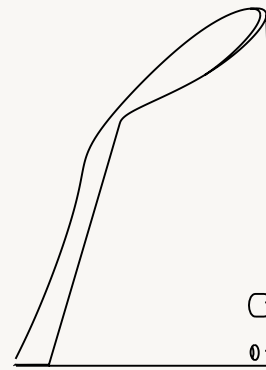

30 cm / 11.8 in

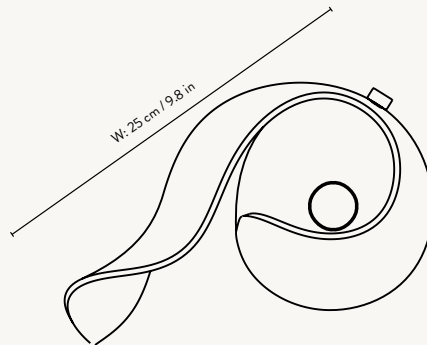

W: 25 cm / 9.8 in

OYSTER WALL LAMP

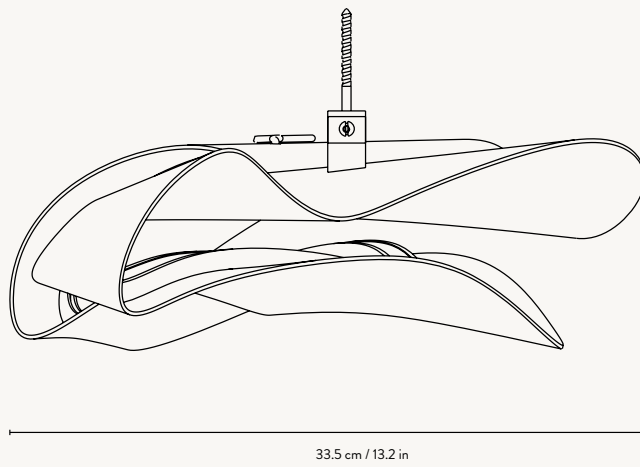
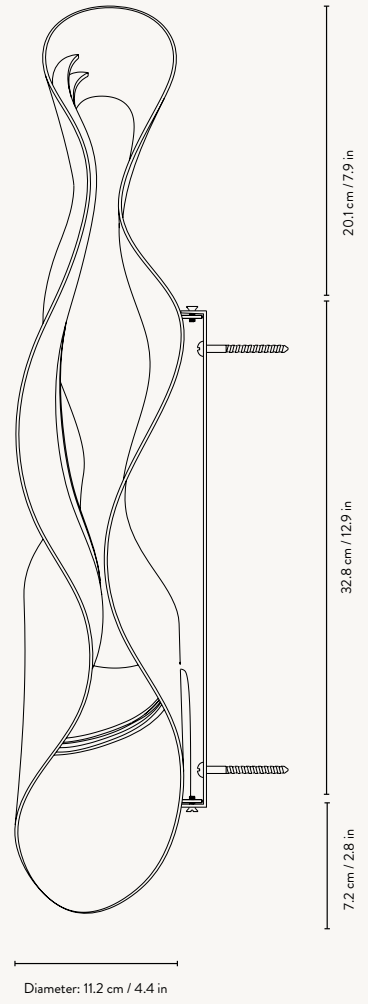
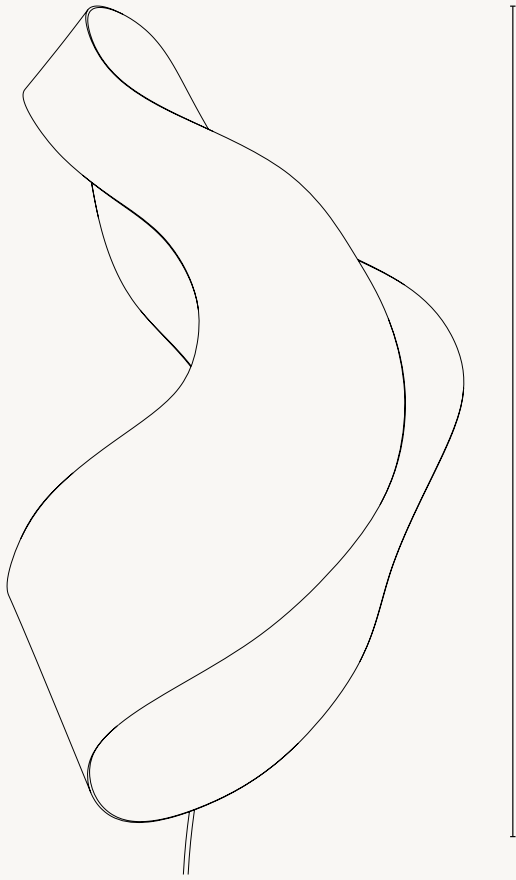

# Oyster Table Lamp

Recycled  
aluminium



1104264803  
Black

Made in casted recycled aluminium, the Oyster Table Lamp has a decorative, organic shape due to its soft, lively curves. Reminiscent of oyster shells gathered at the beach, the texture and finish of the lamp has a distinctive, rough expression owing to the casting process, and the interplay between its organic shape and raw surface creates a compelling contrast. Diffusing a soft, cosy light, the Oyster Table Lamp is a functional yet sculptural piece that will elevate your home.

**SIZE:** H: 23.6 X W: 25 X D: 17.3 CM / H: 9.3 X W: 9.8 X D: 6.8 IN · **MATERIAL:** 100% RECYCLED CASTED ALUMINIUM WITH BLACK PATINA. E14 SOCKET AND 2.6 METRE BLACK CABLE · **CARE:** WIPE WITH A DAMP CLOTH · **INFO:** VOLTAGE: 220-240V - 50HZ. DIMMABLE LED OPAL LIGHT BULB E14, 4 WATT INCLUDED. **CERTIFICATIONS:** CE, IP20, CLASS II. ONLY APPROVED FOR EU/NO/CH/UK AND SEPARATE VERSION FOR US. **REGISTERED DESIGN** · **COUNTRY OF ORIGIN:** CHINA · **NET. WEIGHT:** 1.5 KG · **PACKSIZE:** 1

# Oyster Wall Lamp

Recycled  
aluminium



1104264804  
Black

Made in casted recycled aluminium, the Oyster Wall Lamp has a decorative, organic shape due to its soft, lively curves. Reminiscent of oyster shells gathered at the beach, the texture and finish of the lamp has a distinctive, rough expression owing to the casting process, and the interplay between its curved shape and raw surface creates a compelling contrast. Designed with an LED light source, the Oyster Wall Lamp plays with light and shadow to highlight the uniqueness of the material as well as its organic shape.

**SIZE:** H: 60 X W: 33.6 X D: 12.7 CM / H: 23.6 X W: 13.2 X D: 5 IN · **MATERIAL:** 100% RECYCLED CASTED ALUMINIUM WITH BLACK PATINA  
2.6 METRE BLACK CABLE AND ON/OFF SWITCH · **CARE:** WIPE WITH A DAMP CLOTH · **INFO:** VOLTAGE: 220-240V - 50HZ.  
**LIGHT SOURCE:** REPLACEABLE LED STRIP, 8W, 730 LM, 2500 K, CRI > 90. **CERTIFICATIONS:** CE, IP20, CLASS II. ONLY APPROVED  
FOR EU/NO/CH/UK AND SEPARATE VERSION FOR US. **REGISTERED DESIGN** · **COUNTRY OF ORIGIN:** CHINA  
**NET. WEIGHT:** 3.5 KG · **PACKSIZE:** 1





## *Life is full of contrasts*

As we navigate expectations and dreams in the search for meaning and comfort, we long for a balanced life with room for chaos and calm, moments of reflection and times of joy. A place where we can be ourselves, realise the true value of things and feel at home.

Based on a passion for authentic design and clear functionality, we challenge ourselves to shape the future and take pride in creating products that help you balance the contrasts of life.

Our soft forms, rich textures and deep colours allow you to create an authentic and composed atmosphere, while avant-garde shapes, striking patterns and curious details add a touch of the unexpected.

From our base in Copenhagen, we work with artisans around the world, fusing our Scandinavian mindset with global skills and traditions. We take our responsibility to people and the planet seriously and expect the same of our partners.

We create collections of furniture, accessories and lighting, so you can create space to feel comfortably you.

Welcome home.

