

Mingle Series





Mingle Series

Contemporary design, durable materials and elegant finishes meet in our popular Mingle series. Curate your ideal table by combining your chosen table top crafted from natural, FSC™ Mix certified veneer with MDF core with a pair of matching wood or contrasting metal table legs.

PRODUCT INFO

- Product type:** Table top for indoor use
- Origin:** Denmark
- Design:** ferm LIVING
- Safety:** Do not stand on the table. To prevent potential injuries and structural failures, this table should not be used for other than its intended purpose
- Sustainability:** FSC™ Mix certified
- Care instructions:** Clean with a damp cloth tightly wrung out in clean water. Then polish with a soft, dry cloth.



MINGLE DESK TOP 160 CM / WALNUT - VENEER
MINGLE TABLE LEGS W68 / WALNUT - VENEER



MINGLE TABLE TOP ROUND 130 CM / BLACK OAK VENEER
MINGLE TABLE LEGS W48 - STEEL / CHROME



1104264125
Walnut Veneer



100211106
Dark Stained
Oak Veneer



100211210
Natural
Oak Veneer



1104264134
Walnut Veneer



100212672
Black Oak Veneer



100212106
Dark Stained
Oak Veneer



100212210
Natural
Oak Veneer



MINGLE TABLE LEGS W48 - VENEER

Size: H: 71.65 x W: 58 x D: 29.4 cm
H: 28.2 x W: 22.8 x D: 11.6 in
Material: Oak, Dark Stained Oak and Walnut:
FSC™ Mix certified veneer top with
MDF core. Oiled
Black Oak: FSC™ Mix certified veneer
top with MDF core. Lacquered
Care: Wipe with a damp cloth. Do not leave the
surface wet
Info: If you purchase the trestles alone, please
make sure to use the right type of screws for
the tabletop. Legs come with adjustable feet
Country: Denmark
Net. weight: 25.6 kg
Packsize: 1



MINGLE TABLE LEGS W68 - VENEER

Size: H: 71.6 x W: 78.7 x D: 44.4 cm
H: 28.2 x W: 31 x D: 17.5 in
Material: Oak, Dark Stained Oak and Walnut:
FSC™ Mix certified veneer top with
MDF core. Oiled
Black Oak: FSC™ Mix certified veneer
top with MDF core. Lacquered
Care: Wipe with a damp cloth. Do not leave the
surface wet
Info: If you purchase the trestles alone, please
make sure to use the right type of screws for
the tabletop. Legs come with adjustable feet
Country: Denmark
Net. weight: 12 kg
Packsize: 1



9839
Black



9849
Chrome



9834
Black



9848
Chrome







MINGLE TABLE LEGS W48 - STEEL

Size: H: 71 x W: 58 x D: 29.2 cm
H: 28 x W: 22.8 x D: 11.5 in
Material: Powder coated steel
Chrome plated steel
Care: Wipe with a damp cloth
Info: If you purchase the trestles alone,
please make sure to use the right type
of screws for the table top.
Legs come with adjustable feet.
Registered design
Country: Sweden
Net. weight: 7 kg
Packsize: 1

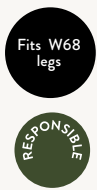
MINGLE TABLE LEGS W68 - STEEL

Size: H: 71 x W: 79 x D: 44.4 cm
H: 28 x W: 31.1 x D: 17.5 in
Material: Powder coated steel
Chrome plated steel
Care: Wipe with a damp cloth
Info: If you purchase the trestles alone,
please make sure to use the right type
of screws for the table top.
Legs come with adjustable feet.
Registered design
Country: Sweden
Net. weight: 7 kg
Packsize: 1



-  1104264132
Walnut Veneer
-  9802
Black Oak Veneer
-  100137106
Dark Stained Oak Veneer
-  100137210
Natural Oak Veneer



MINGLE TABLE TOP RECTANGULAR 160 CM

Size: H: 2.5 x W: 160 x D: 90 cm
H: 1 x W: 63 x D: 35.4 in

Material: Oak, Dark Stained Oak and Walnut:
FSC™ Mix certified veneer top with
MDF core. Oiled
Black Oak: FSC™ Mix certified veneer
top with MDF core. Lacquered

Care: Wipe with a damp cloth.
Do not leave the surface wet



Info: Fits Table Legs W68

Country: Denmark

Net. weight: 22 kg

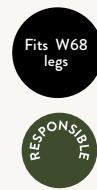
Packsizes: 1



-  1104264131
Walnut Veneer
-  9880
Black Oak Veneer



MINGLE TABLE TOP ROUND 130 CM

Size: Ø: 130 x H: 2.5 cm
Ø: 51.2 x H: 1 in

Material: Oak, Dark Stained Oak and Walnut:
FSC™ Mix certified veneer top with MDF
core. Oiled
Black Oak: FSC™ Mix certified veneer top
with MDF core. Lacquered

Care: Wipe with a damp cloth.
Do not leave the surface wet





Info: Fits Table Legs W68

Country: Denmark

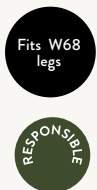
Net. weight: 21 kg

Packsizes: 1



-  1104264130
Walnut Veneer
-  9860
Black Oak Veneer
-  100142106
Dark Stained Oak Veneer
-  100142210
Natural Oak Veneer



MINGLE TABLE TOP OVAL 220 CM

Size: H: 2.5 x W: 220 x D: 90 cm
H: 1 x W: 86.6 x D: 35.4 in

Material: Oak, Dark Stained Oak and Walnut:
FSC™ Mix certified veneer top with
MDF core. Oiled
Black Oak: FSC™ Mix certified veneer
top with MDF core. Lacquered

Care: Wipe with a damp cloth.
Do not leave the surface wet





Info: Fits Table Legs W68

Country: Denmark

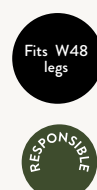
Net. weight: 33 kg

Packsizes: 1



-  1104264127
Walnut Veneer
-  9822
Black Oak Veneer
-  100138106
Dark Stained Oak Veneer
-  100138210
Natural Oak Veneer



MINGLE TABLE TOP RECTANGULAR 210 CM

Size: H: 2.5 x W: 210 x D: 90 cm
H: 1 x W: 82.7 x D: 35.4 in

Material: Oak, Dark Stained Oak and Walnut:
FSC™ Mix certified veneer top with
MDF core. Oiled
Black Oak: FSC™ Mix certified veneer
top with MDF core. Lacquered

Care: Wipe with a damp cloth.
Do not leave the surface wet

Info: Fits Table Legs W68

Country: Denmark

Net. weight: 33 kg

Packsizes: 1

Mingle Steel Table Legs

MINGLE TABLE LEGS - W48
SIDE VIEW

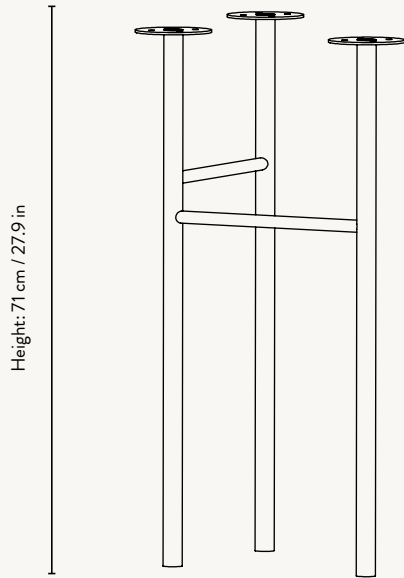

MINGLE TABLE LEGS - W48
TOP VIEW

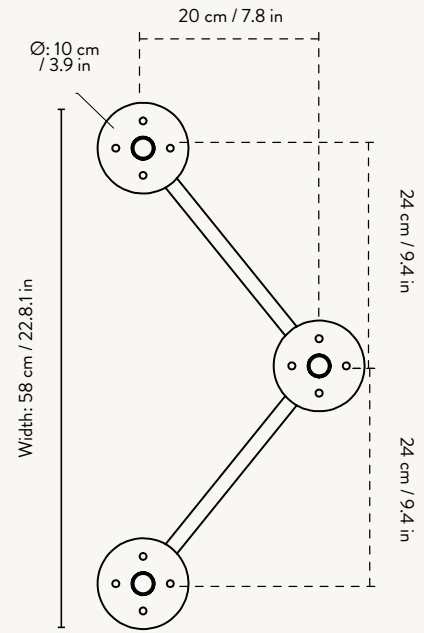

MINGLE TABLE LEGS - W68
SIDE VIEW

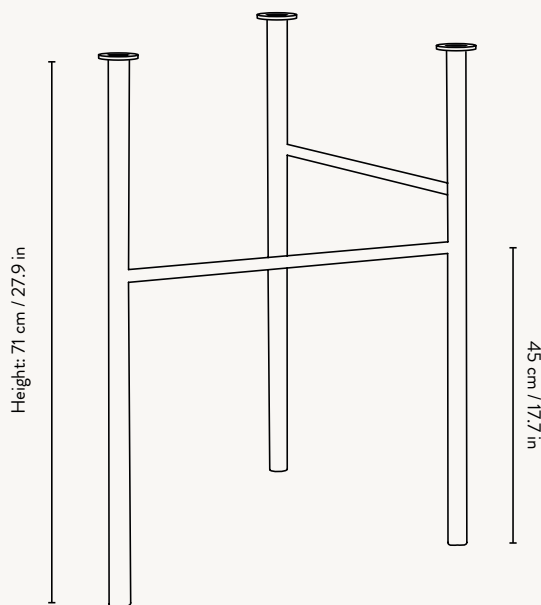

MINGLE TABLE LEGS - W68
TOP VIEW

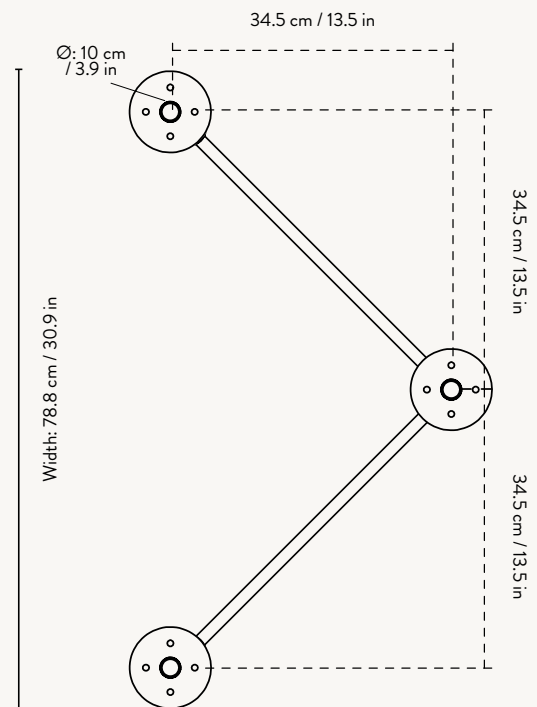

Mingle Wooden Table Legs

MINGLE WOODEN TABLE LEGS - W48
SIDE VIEW

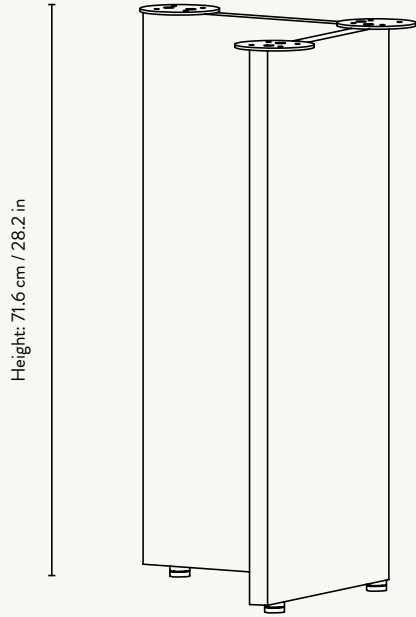

MINGLE WOODEN TABLE LEGS - W48
TOP VIEW

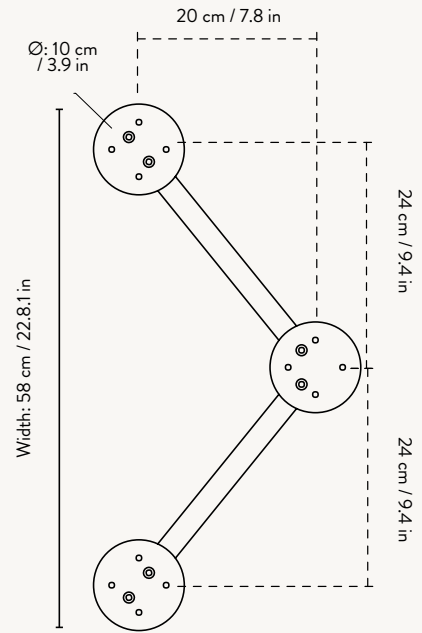

MINGLE WOODEN TABLE LEGS - W68
SIDE VIEW

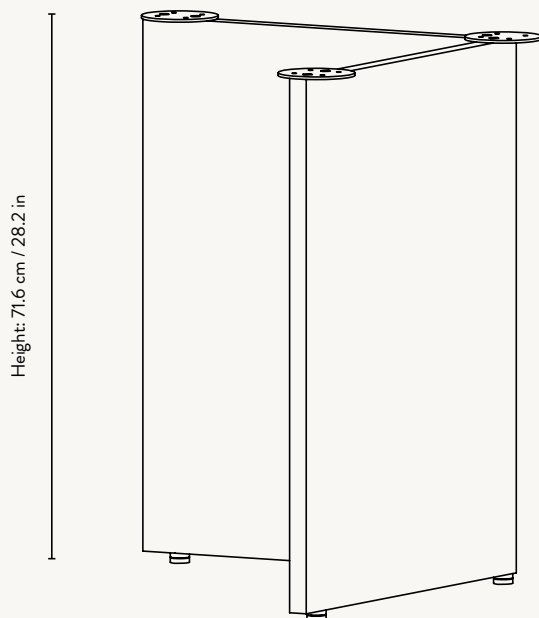

MINGLE WOODEN TABLE LEGS - W68
TOP VIEW

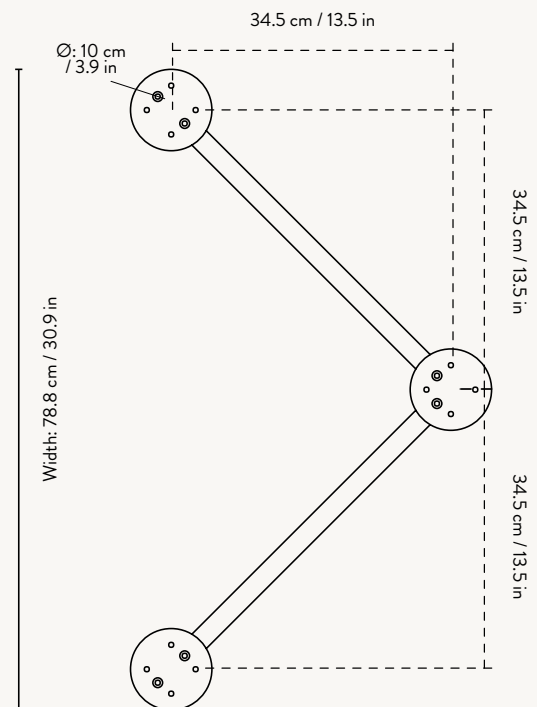

MINGLE DESK - 135 CM

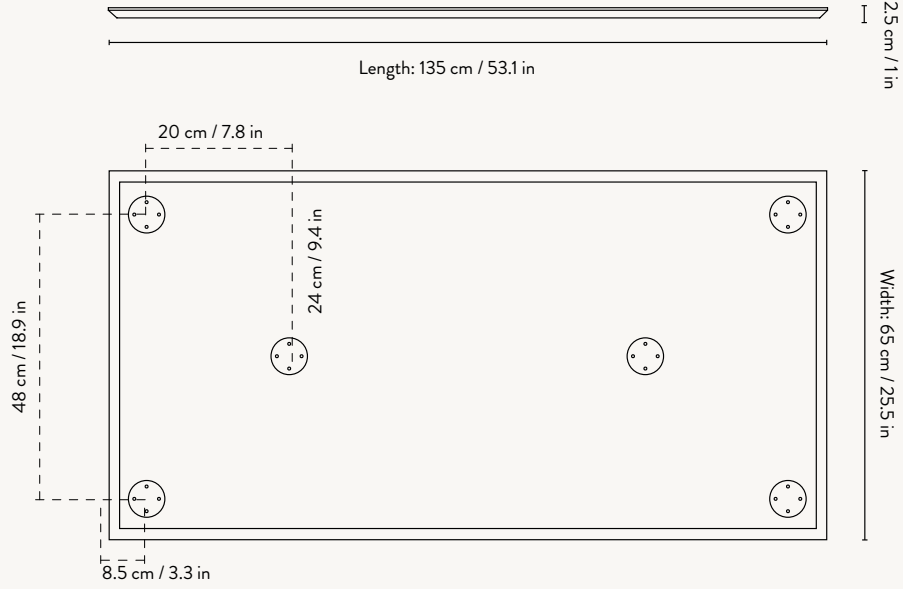

SIDE VIEW

BOTTOM VIEW

MINGLE TABLE TOP - 160 CM

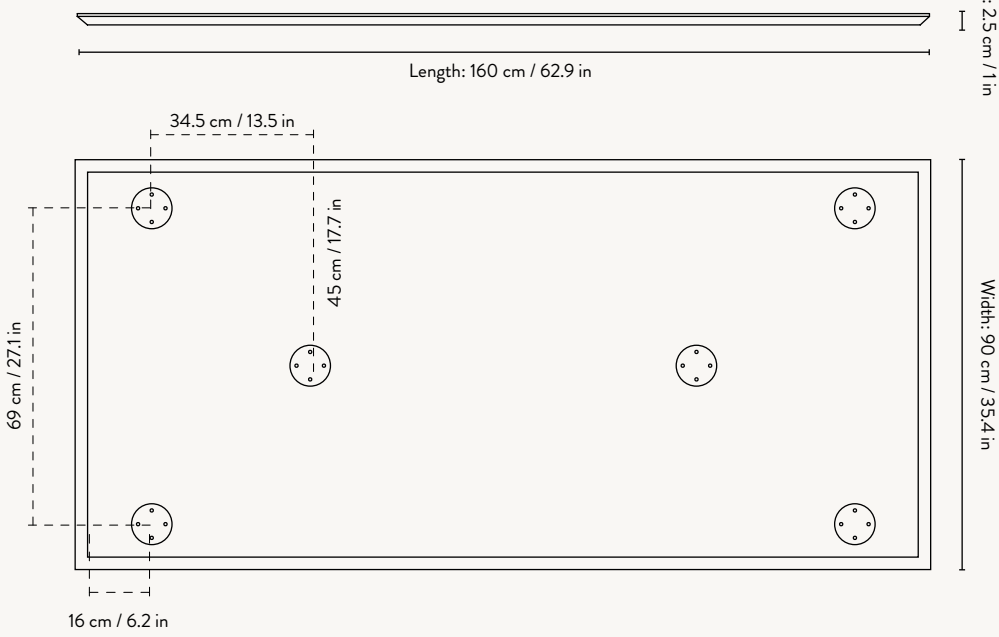

SIDE VIEW

BOTTOM VIEW

MINGLE TABLE TOP - 210 CM

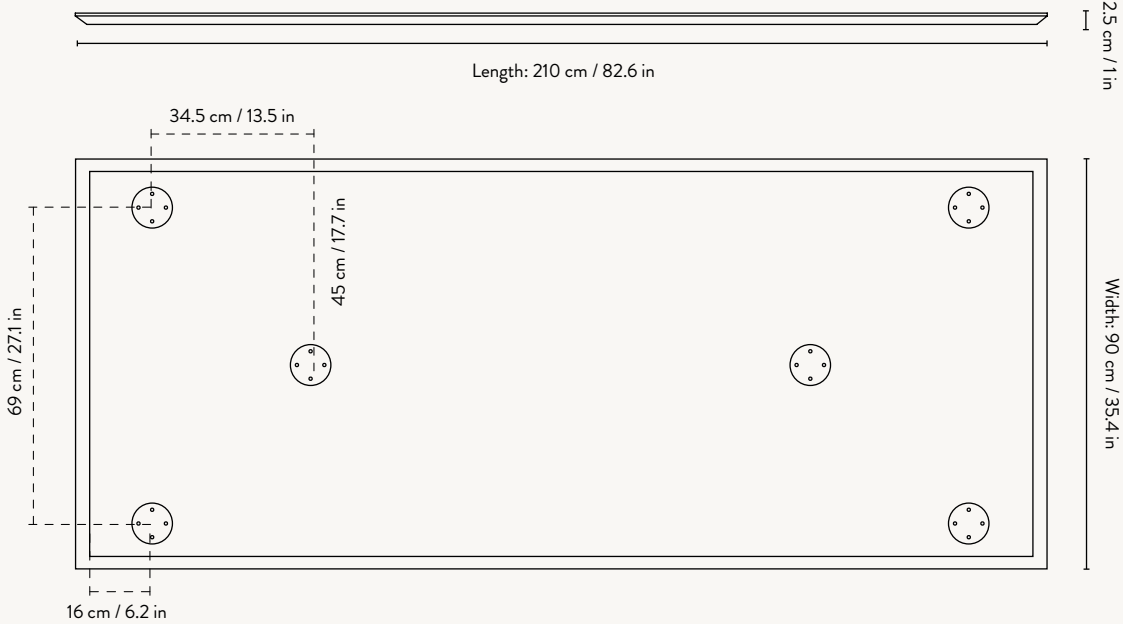

SIDE VIEW

BOTTOM VIEW

MINGLE TABLE TOP - ROUND - 130 CM

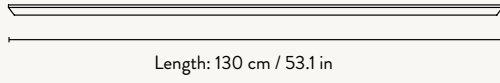

Height: 2.5 cm / 1 in

SIDE VIEW

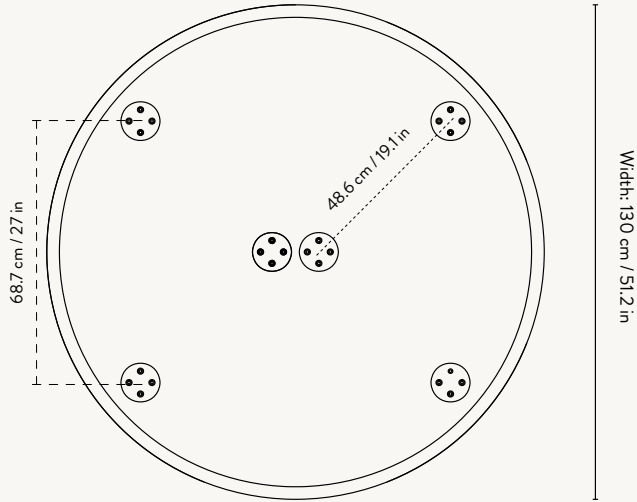

BOTTOM VIEW

MINGLE TABLE TOP - OVAL - 150 CM

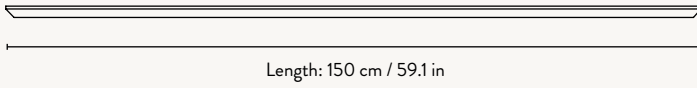

Height: 2.5 cm / 1 in

SIDE VIEW

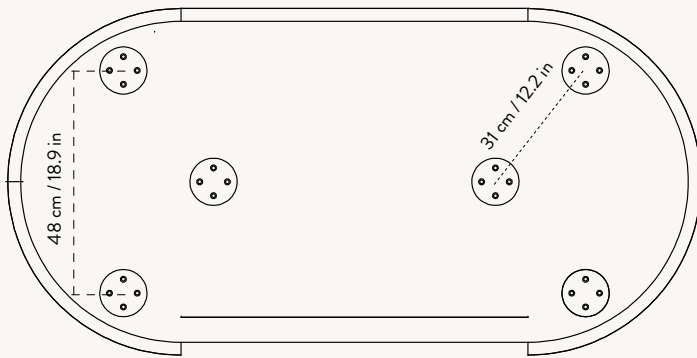

BOTTOM VIEW

MINGLE TABLE TOP - OVAL - 220 CM

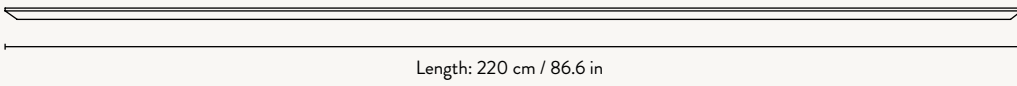

Height: 2.5 cm / 1 in

SIDE VIEW

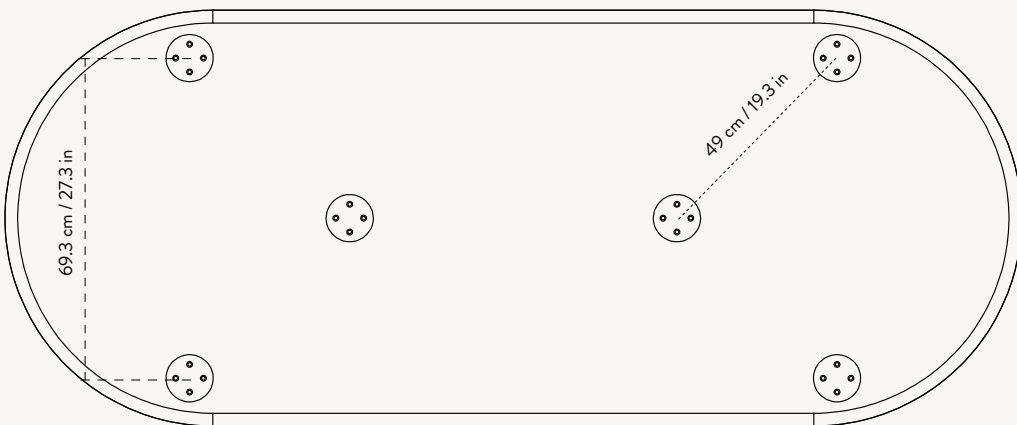

BOTTOM VIEW

Mingle Table Tops

SEATING OVERVIEW

Based upon Herman Chair and 60 cm seating space per person

MINGLE TABLE TOP - ROUND - 130 CM
4 CHAIRS

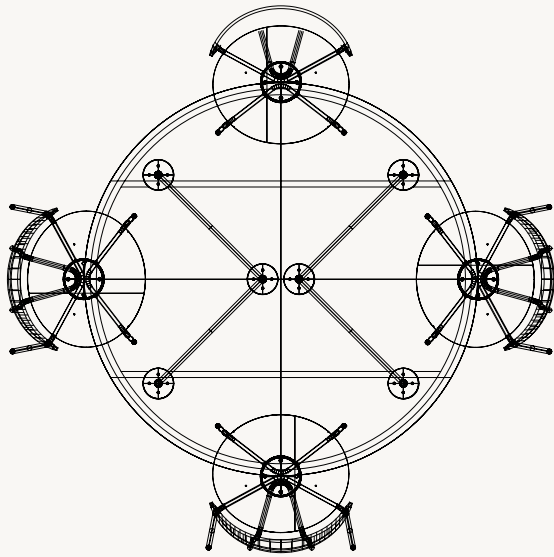

MINGLE TABLE TOP - ROUND - 130 CM
OPTIMIZED SEATING - 8 CHAIRS

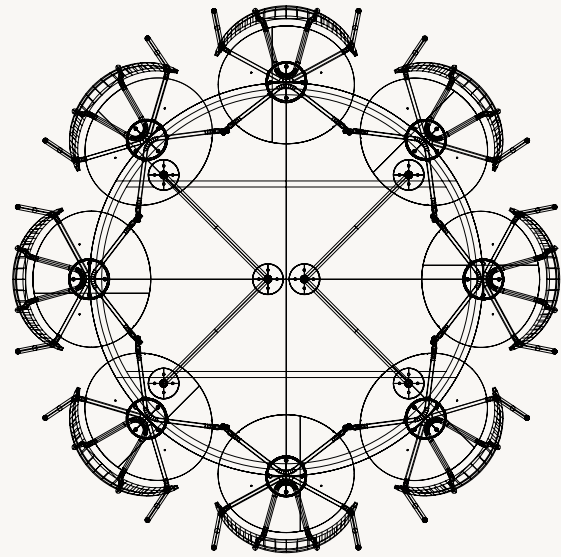

MINGLE TABLE TOP - OVAL - 150 CM
6 CHAIRS

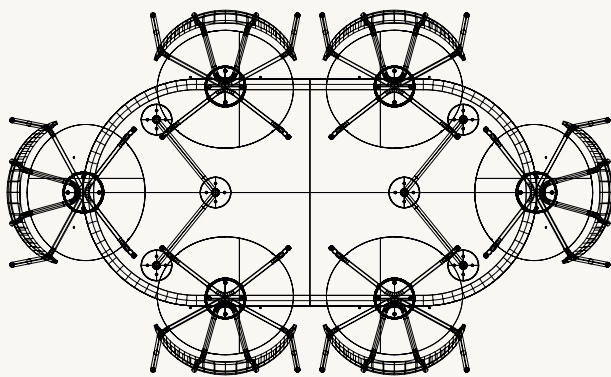

MINGLE TABLE TOP - OVAL - 150 CM
OPTIMIZED SEATING - 6 CHAIRS

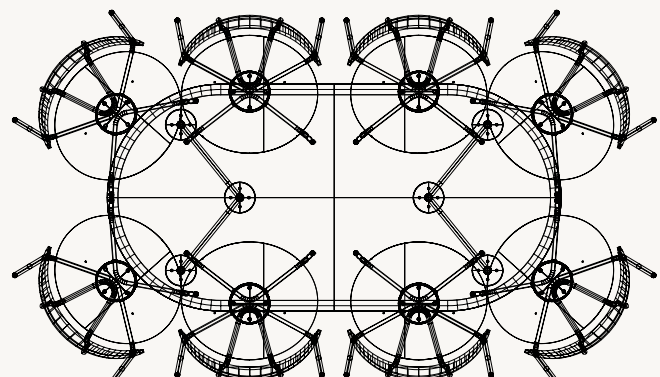

MINGLE TABLE TOP - OVAL - 220 CM
8 CHAIRS

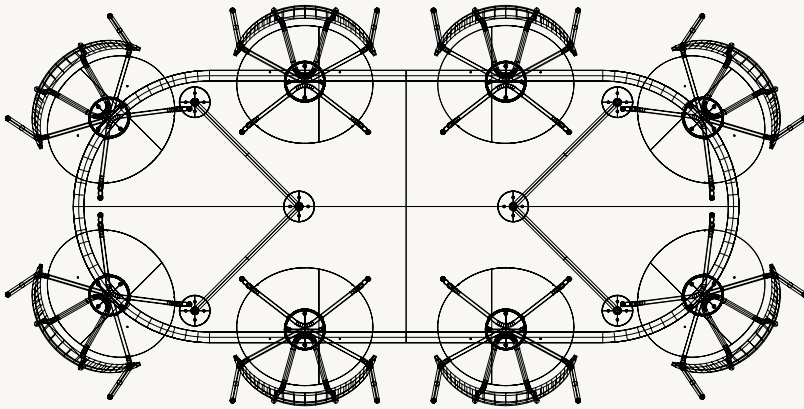

MINGLE DESK - 135 CM
1 CHAIRS

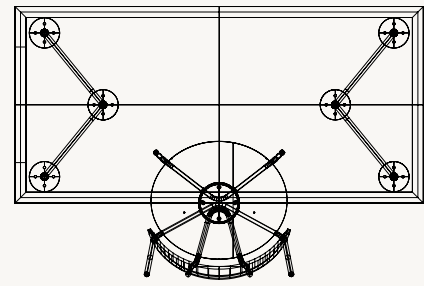

MINGLE TABLE TOP - RECTANGULAR - 210 CM
8 CHAIRS

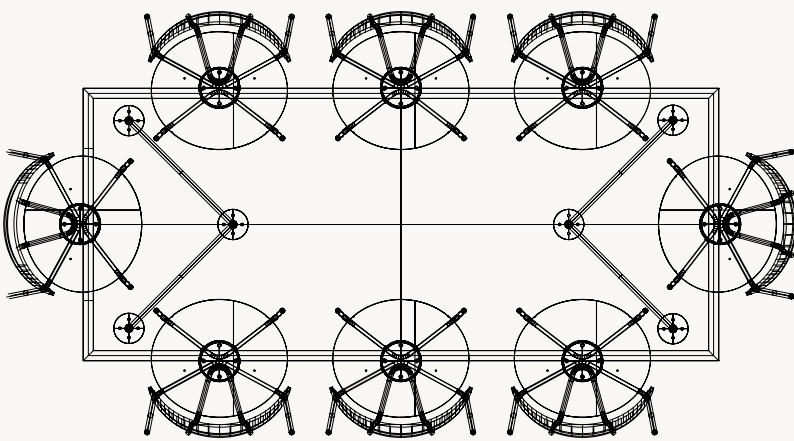

MINGLE TABLE TOP - RECTANGULAR - 160 CM
6 CHAIRS

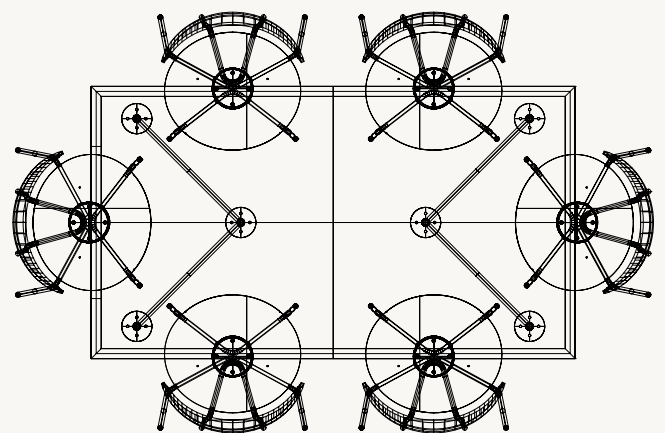

Space to feel comfortably you